

## Gleichstrommotore Baureihe G Option Bremse

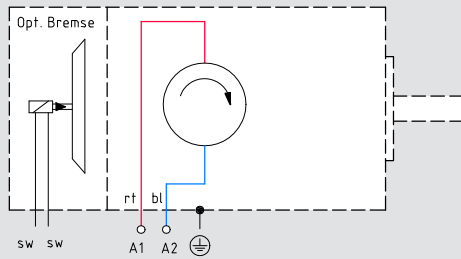

## Gleichstrommotore Baureihe G 5, G 6, G 8

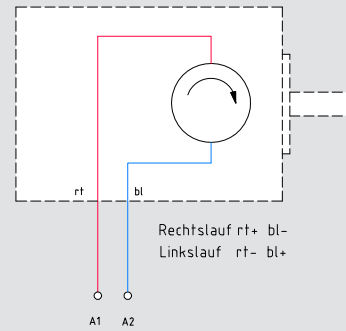

## Gleichstrommotore Baureihe G 5, G 6, G 8 Option Stecker

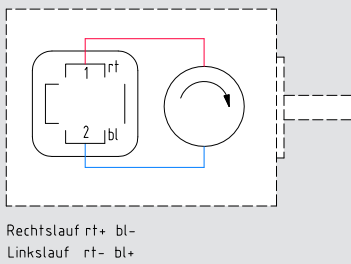

## Gleichstrommotore Baureihe Pg 40, PG 45

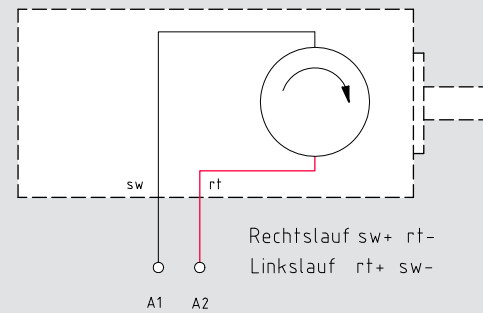

## Gleichstrommotore Baureihe Pg 52, Pg 63, Pg 83, Pg 95

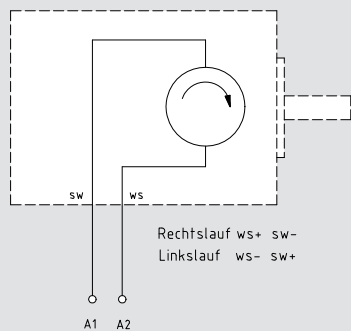

**Motore Baureihe Eg 71, Eg 86, Eg 90**

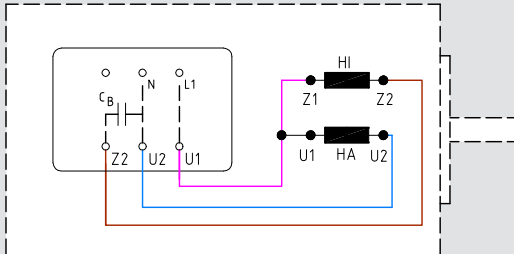

**Motore Baureihe Es 71, Es 86, Es 90**

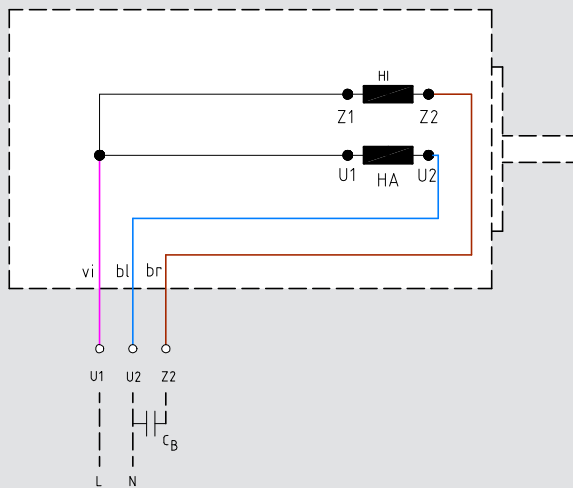

**Wechsel- und Drehstrommotore Baureihe D 5**

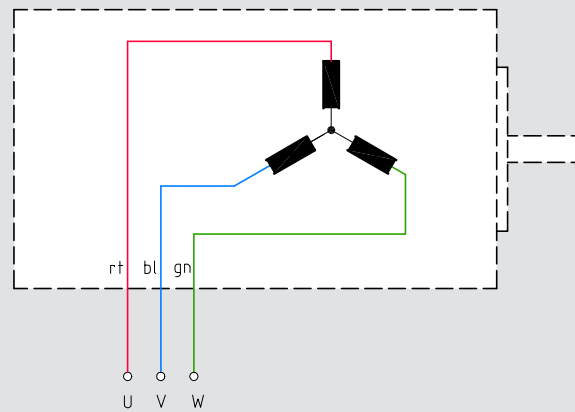

**Wechsel- und Drehstrommotore Baureihe D 6, D 8, D 95**

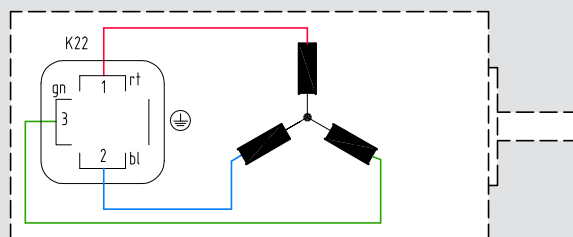

**Wechsel- und Drehstrommotore Baureihe Dg 71, DG 90**

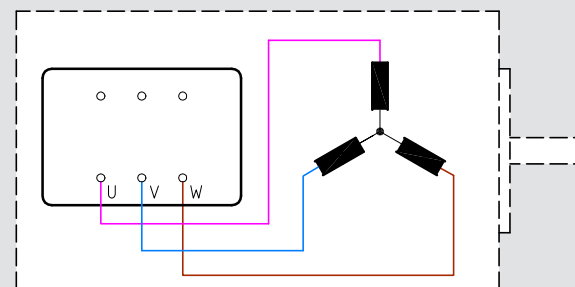

**Wechsel- und Drehstrommotore Baureihe K, D  
Option Bremse**

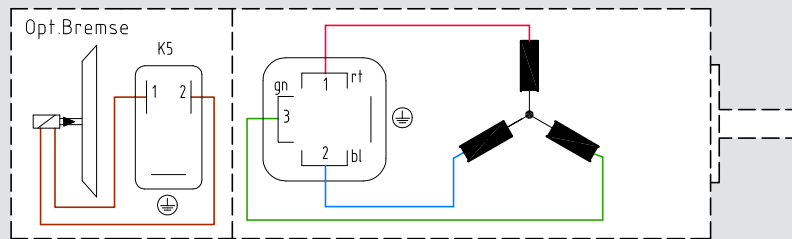

**Wechsel- und Drehstrommotore Baureihe K, D  
Option Bremse, Thermoschalter**

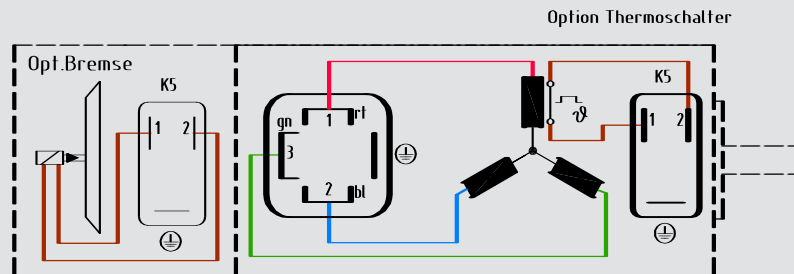

**Wechsel- und Drehstrommotore Baureihe K, D  
Option Kaltleiter**

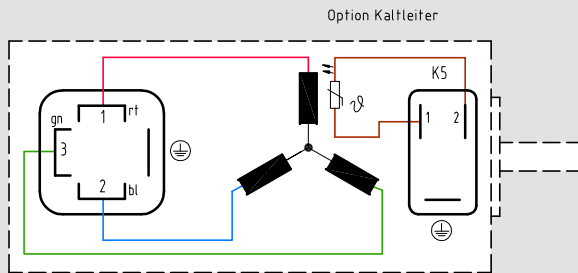

**Wechsel- und Drehstrommotore Baureihe K, D  
Option Thermoschalter**

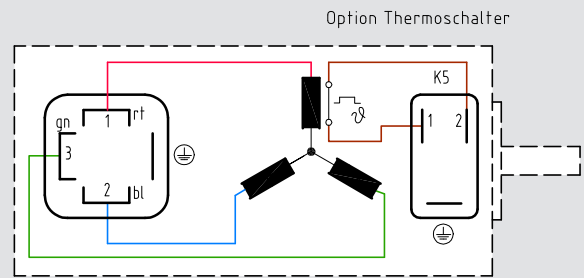

**Wechsel- und Drehstrommotore Baureihe K5**

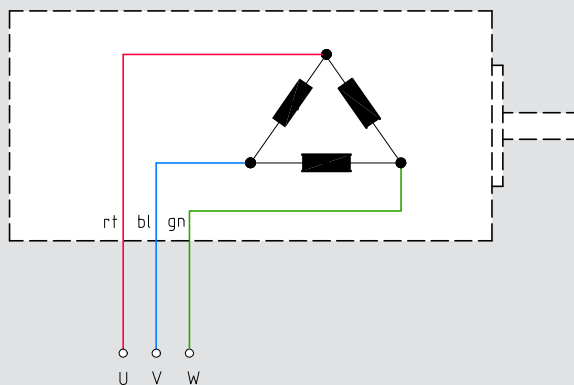

**Wechsel- und Drehstrommotore Baureihe K 6, K 8, K 95**

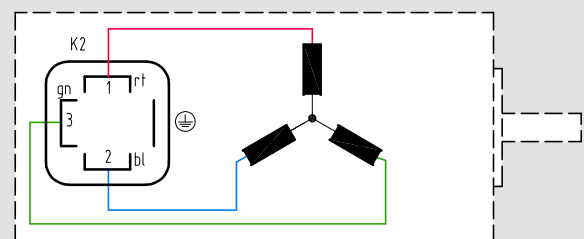

## Motore Baureihe KD 6, KD 8

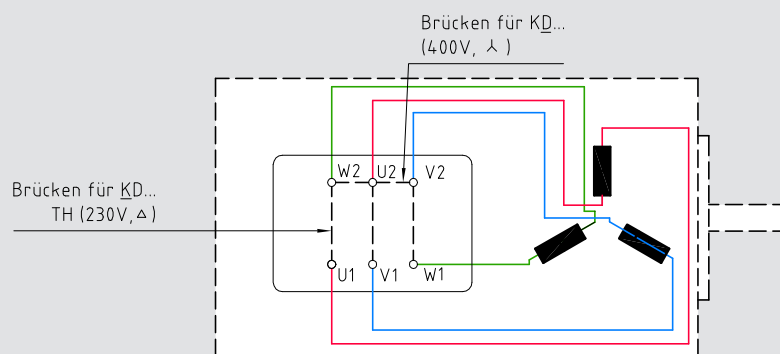

## Gleichstrommotore Baureihe ECs, ECg

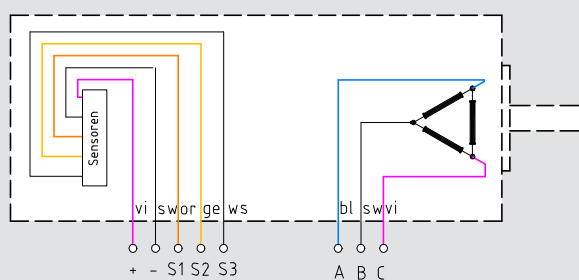

## Gleichstrommotore Baureihe M

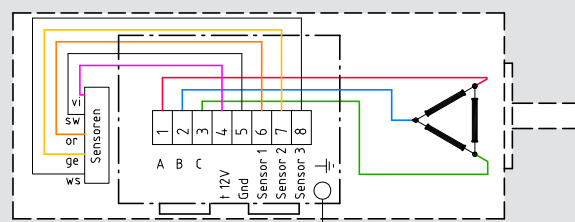

## Motore Baureihe N, MH

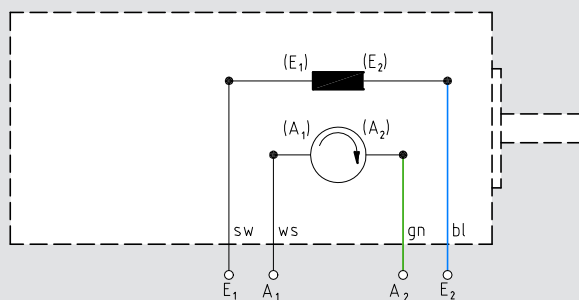

## Drehgeber, Encoder Baureihe RI

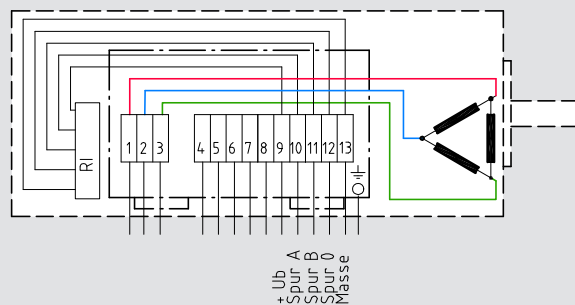

## Universalmotore Baureihe U

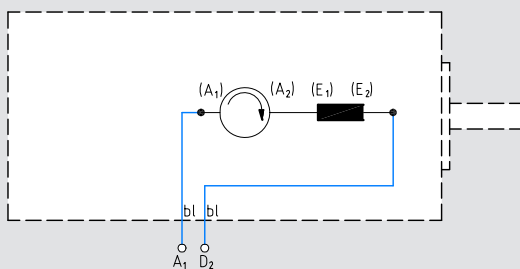

## M und MQ Motor Anschluss K4M

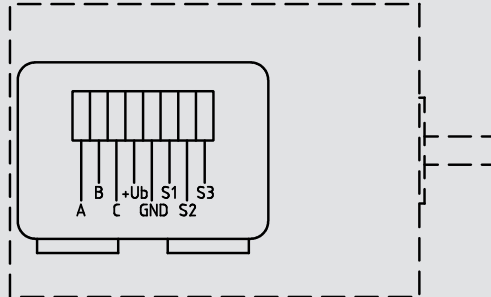

## MQC Motor, Anschluss K4M mit Schraubklemmen

